

**SVASSA15II\_C009**

30.11.2021

**Key-operated switch, maintained, with 4-pole M12 connector**



**General Data**

Type reference	SVASSA15II_C009
Description	Key switch with integrated contact block and 4-pole M12 connector, maintained
Approvals	CE, cURus, ENEC10, VDE, UKCA
Contact type	2 NO
Degree of protection	IP65 (in the front); IP65 / IP67 (on the rear with plugged-in M12 connector)
Connection type	4-pole M12 connector (integrated), A coded
Contact material	AgNi
Max. storage temperature	-40°C ... 80°C
Max. operating temperature	-25°C ... 70°C
Mechanical life	30,000 switching cycles
Electrical life (rated load)	30,000 switching cycles at rated load
Contact resistance NO	< 50 mOhm (new state)
Bouncing time NO	< 10ms

**Electrical data acc. to IEC/EN 60947-5-1 (VDE 0660 Sect. 200)**

	alternate current	direct current
Utilisation category	AC15	DC13
Rated insulation voltage $U_i$	50 V	50 V
Rated operating voltage $U_e$	35 V	35 V
Rated operating current $I_e$	1 A	1 A
Breaking capacity	-	-
Continuous thermal current	1 A	-

**Additional data**

Mounting aperture	22.3 mm
Tightening torque (mounting nut)	1.5 ... 1.9 Nm
Tightening torque (M12-connector)	max. 0.4 Nm
Mounting position	any



Standards EN 60947-5-1, EN 61058-1

Material group I

Overvoltage category II

Pollution degree 2

**Note**

I = NO contact

- stainless steel front ring

Pin assignment:

Pin 1 Pin 2 Pin 3 Pin 4 Type  
COM NO(1) n.c. NO(2) 2 NO

Safety instructions / mounting instructions:

- the connector must not be connected or disconnected under load

**Test data acc. to UL60947-5-1 / C22.2 No. 60947-5-1**

Rating 24 V DC 1 A general purpose

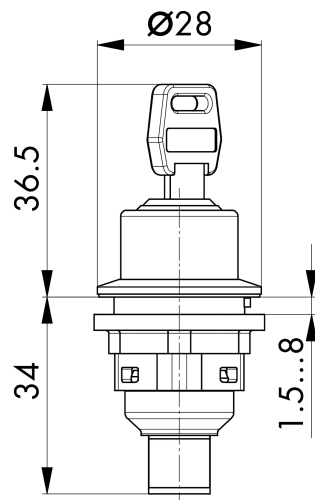

PIN 1/ PIN 2  
PIN 1/ PIN 4  
PIN 3 n.c.

